



DESIGN / BUILD / INNOVATE
DISEÑAR / CONSTRUIR / INNOVAR

GENERAL CATALOGUE CATÁLOGO GENERAL



2025







30 YEAR SERVICE LIFE AÑOS DE VIDA ÚTIL



DESIGN

All products are designed at our factory in Pamplona.

Our design guidelines are functionality, ergonomics, asepsis, a tasteful design.

BUILD

The components used are mainly manufactured in Spain and Germany.

We cooperate with a network of approximately 60 suppliers.

The components designed by Insausti technical office are manufactured in suppliers production plants.

All trolleys and accessories are assembled upon request at our factory in Pamplona.

INNOVATE

Insausti products are developed for health professionals who think long-term and wish to offer their patients an excellent human and technical service.

DISEÑAR

Todos los productos se diseñan en nuestra fábrica de Pamplona.

Las pautas de diseño son funcionalidad, ergonomía, asepsia, cuidado de la estética.

CONSTRUIR

Los componentes utilizados se fabrican principalmente en España y Alemania. Colaboramos con una red de 60 proveedores aproximadamente.

Los componentes diseñados en la oficina técnica de Insausti se fabrican en las plantas de producción de los proveedores.

Todos los carros y los accesorios se ensamblan bajo pedido en nuestra fábrica de Pamplona.

INNOVAR

Los productos de Insausti se desarrollan para los profesionales de la salud que piensan a largo plazo, que desean ofrecer a los pacientes un servicio humano y técnico excelente.

INDEX ÍNDICE

1 - TECHNICAL FEATURES CARACTERÍSTICAS TÉCNICAS	6
2 - MEDICAL TROLLEYS CARROS MÉDICOS	
LOW TROLLEYS CARROS BAJOS	16
MULTIFUNCTION MULTIFUNCIÓN	
SQS SERIES SERIE	18
300 SERIES SERIE	22
PLASTER TROLLEY CARRO DE YESOS	28
DIFFICULT INTUBATION / ISOLATION INTUBACIÓN DIFÍCIL / AISLAMIENTO	29
MRI	30
OPERATING ROOM QUIRÓFANO	
ANAESTHESIA ANESTESIA	33
CATHETER TROLLEYS CARROS DE CATÉTERES	38
STORAGE TROLLEYS CARROS DE ALMACÉN	40
EMERGENCY EMERGENCIA	
SQM SERIES SERIE	44
PAEDIATRIC PEDIÁTRICA	46
100 SERIES SERIE	47
TREATMENT CURAS	
SQM SERIES SERIE	52
100 SERIES SERIE	54
TRANSPORT TROLLEYS WITH CASSETTES CARROS DE TRANSPORTE CON CASETES	60
UNIT DOSE MEDICATION MEDICACIÓN UNIDOSIS	62
TRANSPORT TROLLEYS CARROS DE TRANSPORTE	68
3 - BASIC TROLLEYS CARROS BÁSICOS	
SQS SQUARE TROLLEYS CARROS CUADRADOS	74
OPEN TROLLEYS CARROS ABIERTOS	75
300 SIMPLE TROLLEYS CARROS SIMPLES	76
300 DOUBLE TROLLEYS CARROS DOBLES	78
LOW TROLLEYS CARROS BAJOS	80
SQM SQUARE TROLLEYS CARROS CUADRADOS	82
100 SIMPLE TROLLEYS CARROS SIMPLES	83
4 - ACCESSORIES ACCESORIOS	84

TECHNICAL FEATURES CARACTERÍSTICAS TÉCNICAS

SQUARE TROLLEY CARRO CUADRADO

~~ISO~~ 480 x 480 mm

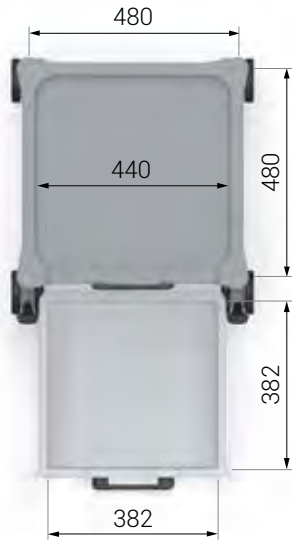

SQS



SQM



DOUBLE TROLLEY CARRO DOBLE

ISO 900 x 630 mm

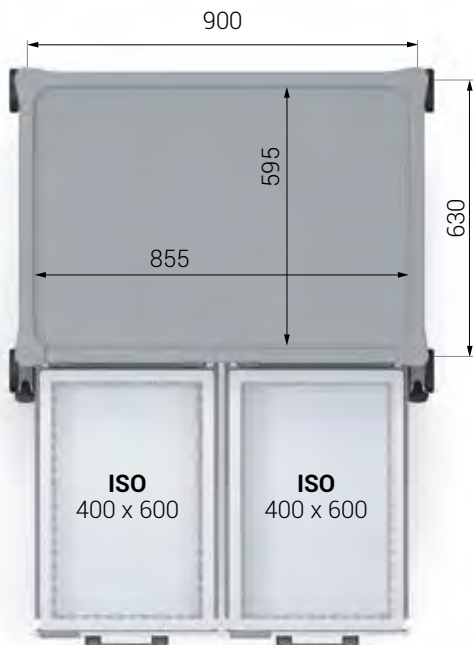

300 SERIES SERIE

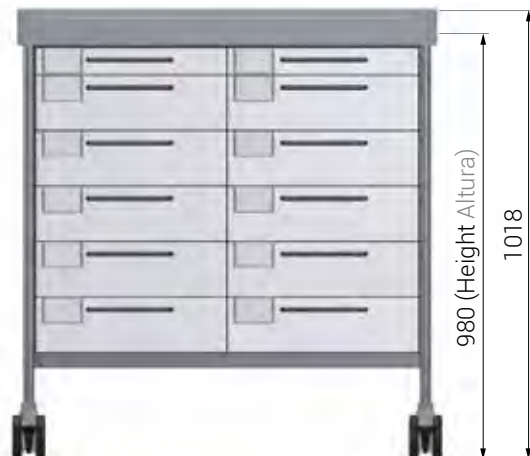

TECHNICAL FEATURES CARACTERÍSTICAS TÉCNICAS

SIMPLE TROLLEY CARRO SIMPLE

ISO 640 x 480 mm

ISO International Organization for Standardisation, ISO norm 3394
600 x 400 mm ISO drawers. Standard, interchangeable with hospital ISO furniture

ISO Organización Internacional de Normalización, norma ISO 3394
Cajones ISO 600 x 400 mm. Estándar, intercambiables con el mobiliario ISO del hospital

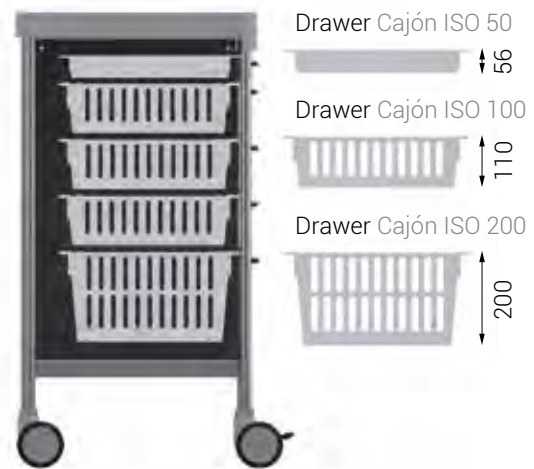
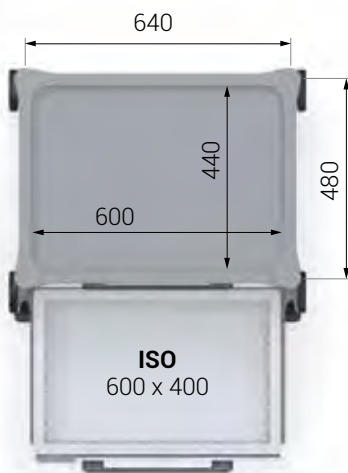

LOW BAJO



300 SERIES SERIE



100 SERIES SERIE



TECHNICAL FEATURES CARACTERÍSTICAS TÉCNICAS

~~ISO~~

SQUARE TROLLEY CARRO CUADRADO CE

480 x 480 mm

SOFT CLOSING SLIDES (Optional)
No closing noise is produced
Operating room, reanimation area, ICU

CORREDERAS CIERRE SUAVE (Opcional)
No se produce ruido de cierre
Quirófano, URPA, UCI



ASF



Prepared for elevated accessories

Preparado para accesorios elevados

PE
SANITIZED
DESINFECTADO

Ergonomic handle

Asa ergonómica

Total opening
Steel ball-bearing slides
with retention system, 20 kg

Apertura total
Correderas de bolas de
acero con sistema de
retención, 20 kg

PP
SANITIZED
DESINFECTADO



Cap Tapón

Front stop
It protects the slide against
strong impacts when closing

Tope frontal
Protege la corredera contra
fuertes impactos de cierre

Prepared for ref. 32R, 37R, 39, 50, 51, 57

Preparado para ref. 32R, 37R, 39, 50, 51, 57

TECHNICAL FEATURES CARACTERÍSTICAS TÉCNICAS

ISO

SIMPLE TROLLEY CARRO SIMPLE CE
DOUBLE TROLLEY CARRO DOBLE CE

640 x 480 mm
900 x 630 mm

SOFT CLOSING SLIDES (Optional)
 No closing noise is produced
 Operating room, reanimation area, ICU

CORREDERAS CIERRE SUAVE (Opcional)
 No se produce ruido de cierre
 Quirófano, URPA, UCI



Prepared for elevated accessories
 Preparado para accesorios elevados



ASF Simple trolley Carro simple
 ASFN Double trolley Carro doble

PE
SANITIZED
 DESINFECTADO



Cap Tapón

Ergonomic handle
 Asa ergonómica

Total opening
 Steel ball-bearing slides with retention system, 20 kg

Apertura total
 Correderas de bolas de acero con sistema de retención, 20 kg

PE
SANITIZED
 DESINFECTADO

ABS

Front stop
 It protects the slide against strong impacts when closing

Top frontal
 Protege la corredera contra fuertes impactos de cierre

Prepared for ref. 32L, 37L, 32NL, 37NL
 Preparado para ref. 32L, 37L, 32NL, 37NL

TECHNICAL FEATURES CARACTERÍSTICAS TÉCNICAS

MONOBLOC STRUCTURE ESTRUCTURA MONOBLOQUE

AISI-304 stainless steel
Assembly with rivets and TIG welding
Side panels prepared for accessories (holes with caps)

Acero inoxidable AISI-304
Ensamblaje con remaches y soldadura TIG
Paneles laterales preparados para accesorios (agujeros con tapones)



PE, PP SANITIZED DESINFECTADO

Withstand disinfectants for the elimination of pathogens
Withstand 100% pure alcohol (not diluted), bleach, detergent, soap solutions, oils, polish, aqueous ammonia, chlorhexidine
Withstand constant cleaning protocols, they do not degrade

Resisten los desinfectantes para la eliminación de los agentes patógenos
Resisten alcohol puro 100% (sin diluir), lejía, detergente, soluciones jabonosas, aceites, grasas, amoníaco acuoso, clorhexidina
Resisten protocolos de limpieza constantes, no se degradan

PE, POLYETHYLENE WORK SURFACE

SUPERFICIE DE TRABAJO DE POLIETILENO

Protection on all 4 sides
Protección en los 4 lados



TECHNICAL FEATURES CARACTERÍSTICAS TÉCNICAS

PP, POLYPROPYLENE SQUARE DRAWERS

~~ISO~~ **480 x 480 mm**

PP, CAJONES CUADRADOS DE POLIPROPILENO

Polypropylene drawers, PP, manufactured in a single piece with slots for optional dividers.
Heights 57, 130 mm.

Cajones de polipropileno, PP, fabricados en una única pieza con ranuras para separadores opcionales.
Alturas 57, 130 mm.



ISO DRAWERS CAJONES ISO 600 x 400 mm

ISO 640 x 480 mm

ABS ISO drawers of standard dimensions according to ISO 3394.
Heights 50, 100, 200 mm.

900 x 630 mm

Cajones ISO de ABS de medidas estándar según norma ISO 3394.
Alturas 50, 100, 200 mm.



TECHNICAL FEATURES CARACTERÍSTICAS TÉCNICAS



STATIC TROLLEYS CARROS ESTÁTICOS

SQS SERIES SERIE - 480 x 480 mm

- The work surface design allows you to move the trolley easily
- Ø 100 mm wheels, 2 antistatic, 2 with brake
- El diseño de la superficie de trabajo permite manejar el carro con facilidad
- Ruedas Ø 100 mm, 2 antiestáticas, 2 con freno

CE



300 SERIES SERIE - ISO 640 x 480 mm

- The work surface design allows you to move the trolley easily
- Ø 100 mm wheels, 2 antistatic, 2 with brake
- El diseño de la superficie de trabajo permite manejar el carro con facilidad
- Ruedas Ø 100 mm, 2 antiestáticas, 2 con freno

CE



300 SERIES SERIE - ISO 900 x 630 mm

- The work surface design allows you to move the trolley easily
- Ø 100 mm wheels, 2 antistatic, 2 with brake
- El diseño de la superficie de trabajo permite manejar el carro con facilidad
- Ruedas Ø 100 mm, 2 antiestáticas, 2 con freno

CE



700 SERIES SERIE - ISO 640 x 480 / 900 x 630 mm

- Phenolic or methacrylate doors
- Key locking
- Handles, left side
- Ø 100 mm wheels, 2 antistatic, 2 with brake
- Puertas de fenólico o metacrilato
- Bloqueo de llave
- Asas, lado izquierdo
- Ruedas Ø 100 mm, 2 antiestáticas, 2 con freno



TECHNICAL FEATURES CARACTERÍSTICAS TÉCNICAS

EXTENSIVE MOBILITY TROLLEYS CARROS ALTA MOVILIDAD

SQM SERIES SERIE - 480 x 480 mm

- Elevated push handle, left side
- Bumpers for hits
- Ø 125 mm simple wheels, 2 antistatic, 2 with brake
- Tirador elevado, lado izquierdo
- Protectores paragolpes
- Ruedas simples Ø 125 mm, 2 antiestáticas, 2 con freno



CE



100 SERIES SERIE - ISO 640 x 480 mm

- Elevated push handle, left side
- Bumpers for hits
- Ø 125 mm double wheels, 2 antistatic, 2 with brake
- Tirador elevado, lado izquierdo
- Protectores paragolpes
- Ruedas dobles Ø 125 mm, 2 antiestáticas, 2 con freno



CE



500 SERIES SERIE - 480 x 480 mm - 640 x 480 mm - 900 x 570 mm



- Elevated push handle, left side
- Bumpers for hits
- Ø 125 mm simple wheels, 2 antistatic, 2 with brake
- Tirador elevado, lado izquierdo
- Protectores paragolpes
- Ruedas simples Ø 125 mm, 2 antiestáticas, 2 con freno

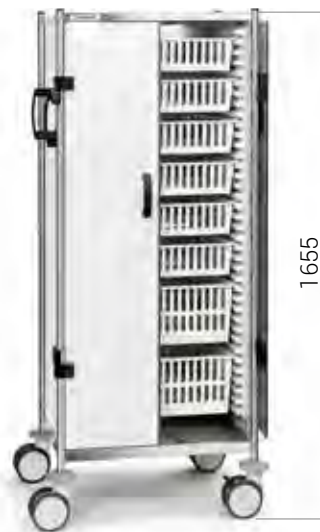

600 SERIES SERIE - 640 x 480 / 900 x 630 mm

- Phenolic or methacrylate doors
- Key locking
- Handles, both sides
- Ø 125 mm double wheels, 2 antistatic, 2 with dual lock
- Puertas de fenólico o metacrilato
- Bloqueo de llave
- Asas, ambos lados
- Ruedas dobles Ø 125 mm, 2 antiestáticas, 2 con doble bloqueo



-  Fixed wheel
Rueda fija
-  Swivel wheel
Rueda giratoria
-  Locked wheel
Rueda bloqueada



TECHNICAL FEATURES CARACTERÍSTICAS TÉCNICAS

SQUARE TROLLEY CARRO CUADRADO

Drawer colour Color de cajones



W White Blanco



B Blue Azul



R Red Rojo

SIMPLE TROLLEY / DOUBLE TROLLEY CARRO SIMPLE / CARRO DOBLE

Front drawer colour Color de frentes de cajón



W White Blanco



B Blue Azul



F Lilac Lila



G Green Verde



Y Yellow Amarillo



R Red Rojo

600 / 700 SERIES SERIE

Doors Puertas



DN HPL phenolic, light grey
HPL fenólico, gris claro



TT Transparent methacrylate
Metacrilato transparente

TECHNICAL FEATURES CARACTERÍSTICAS TÉCNICAS

Plastic material. ISO norm 7810 identification card, international standard

Material plástico. Tarjeta de identificación norma ISO 7810, estándar internacional

SQUARE TROLLEY CARRO CUADRADO

Each drawer includes as standard one white card

Cada cajón incluye de serie una tarjeta blanca

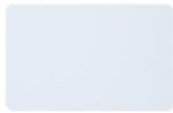

White card
Tarjeta blanca

SIMPLE TROLLEY / DOUBLE TROLLEY CARRO SIMPLE / CARRO DOBLE

Each drawer includes as standard one card holder and one white card

Cada cajón incluye de serie un portatarjetas y una tarjeta blanca



Card holder
Portatarjetas

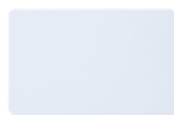

White card
Tarjeta blanca

COLOUR CARDS (Optional) TARJETAS DE COLORES (Opcional)



CR Red Rojo



CG Green Verde



CP Pink Rosa



CB Blue Azul



CO Orange Naranja



CF Lilac Lila



CY Yellow Amarillo



CN Grey Gris



SQ061 W.CR.CP.CO.CY.CG.CB

LOW TROLLEYS, REDUCED HEIGHT
CARROS BAJOS, ALTURA REDUCIDA **CE**

~~ISO~~

480 x 480 mm

GYNECOLOGY, PHLEBOTOMY, OUTPATIENTS CLINICS
GINECOLOGÍA, EXTRACCIONES, CONSULTAS EXTERNAS



STATIC TROLLEYS
CARROS ESTÁTICOS

- DISPOSABLE CONTAINER
- ALCOHOL, CHLORHEXIDINE JARS
- CONTENEDOR DESECHABLE
- BOTES ALCOHOL, CLORHEXIDINA



DIVIDERS (Optional)
SEPARADORES (Opcional)



8 DMQ, 6 DSQ

Q002LW B
SQ061M4LW B.26LW(R1Q)

LOW TROLLEYS, REDUCED HEIGHT
CARROS BAJOS, ALTURA REDUCIDA **CE**

~~ISO~~

480 x 480 mm



STATIC TROLLEYS
CARROS ESTÁTICOS

To store it under 900 mm work tables
 For users working in sitting position

Para guardarlos debajo de mesas de trabajo de 900 mm
 Para el usuario que trabaja en posición sentada



Q011LW W
 SQ064M4LW W.26LW(R2Q).33R.50
 Phlebotomy Extracciones



Q001LW B
 SQ061M4LW B.32R



Q003LW W
 SQ061M4LW W.26LW(R1Q).30.33L



Q004LW W
 SQ061M4LW W.26(RA4Q.A5).32R

ISO 640 x 480 mm



3100LW W
 362M5LW W.32R



3103LW B
 362M5LW B.32L.33R.50



3105LW G
 362M5LW G.26(RA4.A5).32R

MULTIFUNCTION MULTIFUNCIÓN
SQS SERIES SERIE CÉ

~~ISO~~

480 x 480 mm

ICU, CARDIOLOGY, DRESSING, OUTPATIENTS CLINICS

UCI, CARDIOLOGÍA, VENDAJES, CONSULTAS EXTERNAS



STATIC TROLLEYS
CARROS ESTÁTICOS

DIVIDERS (Optional)
SEPARADORES (Opcional)



8 DMQ, 8 DSQ

SYRINGES

JERINGUILLAS



DISPOSABLE
CONTAINER

CONTENEDOR
DESECHABLE

Q091 B
SQ061 B.26(RA4Q.A5).32R

MULTIFUNCTION MULTIFUNCIÓN
SQS SERIES SERIE CE

~~ISO~~
480 x 480 mm

ICU, CARDIOLOGY, DRESSING, OUTPATIENTS CLINICS

UCI, CARDIOLOGÍA, VENDAJES, CONSULTAS EXTERNAS



STATIC TROLLEYS
CARROS ESTÁTICOS

DIVIDERS (Optional)
 SEPARADORES (Opcional)



8 DMQ, 8 DSQ

SYRINGES
 JERINGUILLAS

DISPOSABLE
 CONTAINER
 CONTENEDOR
 DESECHABLE



FOLD
 DOWN TRAY
 BANDEJA
 ABATIBLE

Q096 W
 SQ061 W.26(RA4Q.A5).30.32L

MULTIFUNCTION MULTIFUNCIÓN
SQS SERIES SERIE CÉ

~~ISO~~

480 x 480 mm

ICU, CARDIOLOGY, DRESSING, OUTPATIENTS CLINICS

UCI, CARDIOLOGÍA, VENDAJES, CONSULTAS EXTERNAS



STATIC TROLLEYS
CARROS ESTÁTICOS

DIVIDERS (Optional)
SEPARADORES (Opcional)



8 DMQ, 8 DSQ

SYRINGES

JERINGUILLAS

ALCOHOL, CHLORHEXIDINE JARS

BOTES ALCOHOL, CLORHEXIDINA

DISPOSABLE
CONTAINER

CONTENEDOR
DESECHABLE

FOLD
DOWN TRAY

BANDEJA
ABATIBLE



Q092 W.(6)CP

SQ061 W.26(RA5Q.A5.R1Q).30.33L.(6)CP

MULTIFUNCTION MULTIFUNCIÓN
SQS SERIES SERIE CÉ

~~ISO~~
480 x 480 mm



STATIC TROLLEYS
CARROS ESTÁTICOS



Q024 W
 SQ021 W.26LW(R1Q)



Q025 W
 SQ022 W.32R



Q027 B
 SQ021TXQ B.26M(R75QM)



Q054 B
 SQ061 B.32R



Q058 B
 SQ061 B.32R.46



Q063 W
 SQ061 W.32L.33R.50



Q064 W
 SQ061 W.26(RA4Q.A5).32L.33R.50



Q072 B
 SQ061 B.30.32L



Q077 W
 SQ061 W.26LW(R1Q).30.33L

MULTIFUNCTION MULTIFUNCIÓN
300 SERIES SERIE CE

ISO
640 x 480 mm

ICU, CARDIOLOGY, DRESSING, OUTPATIENTS CLINICS
 UCI, CARDIOLOGÍA, VENDAJES, CONSULTAS EXTERNAS

 **STATIC TROLLEYS**
CARROS ESTÁTICOS

- ALCOHOL,
CHLORHEXIDINE JARS
- GLOVE BOX
- BOTES ALCOHOL,
CLORHEXIDINA
- CAJA DE GUANTES

DIVIDERS (Optional)
 SEPARADORES (Opcional)



H5/8, (3)H10/4, H20/4



DISPOSABLE
 CONTAINER

CONTENEDOR
 DESECHABLE



Contaminated
 waste on right side

Desechos
 contaminados en
 lado derecho

WASTE BIN

CUBO DESECHOS

3151 B
 365 B.26LW(R1).33R.50

MULTIFUNCTION MULTIFUNCIÓN
300 SERIES SERIE CE

ISO
640 x 480 mm

ICU, CARDIOLOGY, DRESSING, OUTPATIENTS CLINICS

UCI, CARDIOLOGÍA, VENDAJES, CONSULTAS EXTERNAS



STATIC TROLLEYS
CARROS ESTÁTICOS

DIVIDERS (Optional)
 SEPARADORES (Opcional)



H5/8, (3)H10/4, H20/4

- ALCOHOL,
CHLORHEXIDINE JARS
- DISPOSABLE CONTAINER
- BOTES ALCOHOL,
CLORHEXIDINA
- CONTENEDOR DESECHABLE



3 GLOVE BOX
 3 CAJAS DE
 GUANTES

WASTE BIN
 CUBO DESECHOS

3133 W
 365 W.26LW(R1).46.50

MULTIFUNCTION MULTIFUNCIÓN OPEN TROLLEY CARRO ABIERTO CE

ISO

640 x 480 mm

ICU, CARDIOLOGY, DRESSING, OUTPATIENTS CLINICS

UCI, CARDIOLOGÍA, VENDAJES, CONSULTAS EXTERNAS



STATIC TROLLEYS
CARROS ESTÁTICOS



Retention stop rails
Guías con tope de retención



365AB

CENTRAL SUPPORT (Optional)
SOPORTE CENTRAL (Opcional)



26LW(R1)

SIDE SUPPORT (Optional)
SOPORTE LATERAL (Opcional)



32R

BIN (Optional)
CUBO (Opcional)



50AB - 13 Litres Litros
50BAB - 2 x 13 Litres Litros
51AB - 26 Litres Litros

MULTIFUNCTION MULTIFUNCIÓN
300 SERIES SERIE CÉ

ISO
640 x 480 mm



STATIC TROLLEYS
CARROS ESTÁTICOS



3102 B
 322 B.32R



3107 G
 333 G.32R



3105 Y
 332 Y.26LW(R1)



3129 W
 365 W.32R



3127 B
 365 B.32R.46



3153 W
 365 W.(2)32L.33R.50



3140 B
 365 B.26LW(R1).30.46.50



3157 W
 365 W.26(R1.R1).33R.50



3145 G
 365 G.26(RA5.A5.R1).32R

MULTIFUNCTION MULTIFUNCIÓN
300 SERIES SERIE CÉ

ISO

900 x 630 mm

TRAUMATOLOGY, DRESSING, SURGERY

TRAUMATOLOGÍA, VENDAJES, CIRUGÍA



STATIC TROLLEYS
CARROS ESTÁTICOS

DIVIDERS (Optional)
SEPARADORES (Opcional)

- ALCOHOL,
CHLORHEXIDINE JARS
- GLOVE BOX

- BOTES ALCOHOL,
CLORHEXIDINA
- CAJA DE GUANTES



(2)H5/8, (6)H10/4, (2)H20/4



DISPOSABLE
CONTAINER

CONTENEDOR
DESECHABLE

3820 B

N365 B.26LW(R1N).32NR

MULTIFUNCTION MULTIFUNCIÓN
300 SERIES SERIE CÉ

ISO
900 x 630 mm

TRAUMATOLOGY, DRESSING, SURGERY
 TRAUMATOLOGÍA, VENDAJES, CIRUGÍA



STATIC TROLLEYS
CARROS ESTÁTICOS



3808
 N305.26LW(R1N)



3800 G
 N322 G.26LW(R1N)



3818 W
 N365 W.26LW(R1N)



3830 Y
 N365 Y.26(R2N.R1N)



3840 W
 N365 W.26(R7N.R7N).32NR



3850 G
 N365 G.26(RA4N.A5).32NR



3860 W
 N362M12 W.26(RA4N.A5).(2)32NR

PLASTER TROLLEY CARRO DE YESOS
300 SERIES SERIE CÉ

ISO
900 x 630 mm

Stainless steel AISI-304 monobloc structure.

Polyethylene work surface, PE

LXN Stainless steel protection, resists contact with fiberglass bandages

Estructura monobloque de acero inoxidable AISI-304

Superficie de trabajo de polietileno, PE

LXN Protección de acero inoxidable, resiste el contacto de vendas con fibra de vidrio

BANDAGE SHELF ROLLS
ESTANTE ROLLOS VENDAS

5 dividers, adjustable
5 separadores, regulables



R12N

1 PLASTER-BASIN SUPPORT
SOPORTE 1 CUBETA PARA YESO

8.8 litres, PC transparent
Removable, supports on ref. 37NR

8.8 litros, PC transparente
Desmontable, apoya en ref. 37NR



49



3892 W

N322 W.LXN.26(R12N.R2N).37NR.49

DIFFICULT INTUBATION INTUBACIÓN DIFÍCIL
300 SERIES SERIE CÉ

ISO
640 x 480 mm



3702 W
 364M6 W.12B.14.32R



3708 W
 364M6 W.12B.14.26LW(R2).32R.36.44L

SUCTION UNIT SUPPORT
 (Optional)
 SOPORTE ASPIRADOR
 (Opcional)



39

ISOLATION AISLAMIENTO
300 SERIES SERIE CÉ

ISO
640 x 480 mm

Infection control

To store protective disposable material, clothes, caps, masks, gloves, hose

Control de infecciones

Para almacenar material desechable de protección, ropa, gorros, mascarillas, guantes, calzas



3732 Y
 366M6 Y.46



3738 Y
 366M6 Y.46.48L.51

GOWN SUPPORT
 (Optional)
 SOPORTE PARA BATAS
 (Opcional)



41

 **STATIC TROLLEYS**
CARROS ESTÁTICOS



3 Tesla

Certificate of MRI conformance
Certificado de conformidad MRI

DIVIDERS (Optional)
SEPARADORES (Opcional)



H5/8, (3)H10/4, H20/4

SYRINGES

JERINGUILLAS

KEY LOCKING

(Optional)

BLOQUEO DE LLAVE

(Opcional)



10MR

3 GLOVE BOX HOLDER

(Optional)

SOPORTE 3 CAJAS DE
GUANTES (Opcional)



46

- DISPOSABLE
CONTAINER
- GLOVE BOX

- CONTENEDOR
DESECHABLE
- CAJA DE GUANTES

BIN (Optional)

CUBO (Opcional)



50MR - 13 Litres Litros

51MR - 26 Litres Litros



3607MRI G

365MRI G.26(RA4.A5).32R

Anaesthesia

Anestesia

MRI ROOM SALA DE RESONANCIA MAGNÉTICA MRI **CE**

ISO
640 x 480 mm

 **STATIC TROLLEYS**
CARROS ESTÁTICOS

Trolley manufactured with antimagnetic materials
4 antistatic wheels with brake

Carro fabricado con materiales antimagnéticos
4 ruedas antiestáticas con freno



3 Tesla

Certificate of MRI conformance
Certificado de conformidad MRI



305MRI

Multifunction
Multifunción



3102MRI B
322MRI B.32R

Multifunction
Multifunción



3126MRI W
364MRI W.32R

Multifunction
Multifunción



3129MRI Y
365MRI Y.32R

Multifunction
Multifunción



3232MRI R
365MRI R.12MR.14.(2)32R.36MR.41

Emergency
Emergencia



706MRI OP.(2)60.(4)72.73

Storage
Almacén

OPERATING ROOM QUIRÓFANO



ANAESTHESIA ANESTESIA
300 SERIES SERIE CE

ISO
900 x 630 mm

OPERATING ROOM
QUIRÓFANO

 **STATIC TROLLEYS**
CARROS ESTÁTICOS

DIVIDERS (Optional)
SEPARADORES (Opcional)

SYRINGES
JERINGUILLAS

- MEDICATION LABELS DISPENSER
- GLOVE BOX
- DISPENSADOR ETIQUETAS DE MEDICACIÓN
- CAJA DE GUANTES



(2)H5/16, (6)H10/4, (2)H20/4

DISPOSABLE CONTAINER
CONTENEDOR DESECHABLE

3956 G
N365 G.26(RA4N.A5.R2N).32NR

ANAESTHESIA ANESTESIA
300 SERIES SERIE CE

ISO
640 x 480 mm

EMERGENCY ROOM, OPERATING ROOM, REANIMATION AREA
SERVICIO URGENCIAS, QUIRÓFANO, URPA



STATIC TROLLEYS
CARROS ESTÁTICOS

DIVIDERS (Optional)
SEPARADORES (Opcional)



H5/16, (3)H10/4, H20/4

SYRINGES

JERINGUILLAS



- DISPOSABLE CONTAINER
- GLOVE BOX
- CONTENEDOR DESECHABLE
- CAJA DE GUANTES

3607 G
365 G.26(RA4.A5).32R

ANAESTHESIA ANESTESIA
300 SERIES SERIE CE

ISO
640 x 480 mm

OPERATING ROOM
QUIRÓFANO

 **STATIC TROLLEYS**
CARROS ESTÁTICOS

DIVIDERS (Optional)
SEPARADORES (Opcional)



H5/16, (3)H10/4, H20/4

SYRINGES
JERINGUILLAS

- **MEDICATION LABELS DISPENSER**
 - **GLOVE BOX**

- **DISPENSADOR ETIQUETAS DE**
MEDICACIÓN
 - **CAJA DE GUANTES**

DISPOSABLE
CONTAINER
CONTENEDOR
DESECHABLE

FOLD
DOWN TRAY
BANDEJA
ABATIBLE



3684 B
 365 B.26(RA4.A5.R2).30.32L

**ANAESTHESIA ANESTESIA
300 SERIES SERIE CÉ**

**ISO
640 x 480 mm**

**EMERGENCY ROOM, OPERATING ROOM, REANIMATION AREA
SERVICIO URGENCIAS, QUIRÓFANO, URPA**



**STATIC TROLLEYS
CARROS ESTÁTICOS**

**ANAESTHESIA TROLLEY PREPARED FOR DIGITALIZATION
CARRO DE ANESTESIA PREPARADO PARA DIGITALIZACIÓN**

COMPUTER
ORDENADOR

VESA SUPPORT
3 POSITIONS,
ADJUSTABLE

SOPORTE VESA
3 POSICIONES,
REGULABLE

- DISPOSABLE
CONTAINER
- ALCOHOL,
CHLORHEXIDINE
JARS

- CONTENEDOR
DESECHABLE
- BOTES ALCOHOL,
CLORHEXIDINA

DIVIDERS (Optional)
SEPARADORES (Opcional)



H5/16, (3)H10/4, H20/4

FOLD
DOWN TRAY
BANDEJA
ABATIBLE



3695 W
362M6TX W.26M(R75M).30.(2)32L

ANAESTHESIA ANESTESIA
300 SERIES SERIE CE

ISO
640 x 480 mm



STATIC TROLLEYS
CARROS ESTÁTICOS



3613 W
 362M6 W.26(RA4.A5).32R



3611 G
 365 G.26(RA4.A5).27EV.32R



3650 G
 365 G.26(RA4.A5).30.(2)32L



3680 Y
 365 Y.26(RA5.A5.R1).30.33L



3609 Y
 365 Y.26(RA4.A5).(2)32R.33L



3685 B
 365 B.26(RA4.A5.R2).30.(2)32L



3687 B
 365 B.26(RA4.A5.R2).30.33L.44L



3694 W
 362M6 W.26(RA4.A5.R2).30.32L

CATHETER TROLLEY CARRO DE CATÉTERES 700 SERIES SERIE

**ISO
640 x 480 mm**



**STATIC TROLLEYS
CARROS ESTÁTICOS**

Adjustable shelf, phenolic
600 x 400 mm ISO drawers

Bandeja regulable, fenólico
Cajones ISO 600 x 400 mm

DN Light grey doors Puertas gris claro

TT Transparent doors Puertas transparentes



706 DN.60CAT

**CATHETERS SHELF
BANDEJA PARA CATÉTERES**
25 hooks 25 colgadores



60CAT

**CATHETERS RAIL, 3 HOOKS
(Optional)
RIEL PARA CATÉTERES, 3 GANCHOS
(Opcional)**

Catheters maximum height 1780 mm
Altura máxima catéteres 1780 mm



R7CAT3

**CATHETER TROLLEY CARRO DE CATÉTERES
700 SERIES SERIE**

**ISO
900 x 630 mm**



**STATIC TROLLEYS
CARROS ESTÁTICOS**

Adjustable shelf, phenolic
400 x 600 mm ISO drawers

Bandeja regulable, fenólico
Cajones ISO 400 x 600 mm

DN Light grey doors Puertas gris claro
TT Transparent doors Puertas transparentes



720 TT.62CAT.(2)62.(4)72.73

**CATHETERS SHELF
BANDEJA PARA CATÉTERES**
15 hooks 15 colgadores



62CAT

**CATHETERS RAIL, 4 HOOKS
(Optional)
RIEL PARA CATÉTERES, 4 GANCHOS
(Opcional)**

Catheters maximum height 1780 mm
Altura máxima catéteres 1780 mm



R7CAT4

STORAGE TROLLEY CARRO DE ALMACÉN 700 SERIES SERIE

**ISO
900 x 630 mm**

Monobloc structure of AISI-304 stainless steel
Assembly with rivets and TIG welding
Doors with key locking
400 x 600 mm ISO drawers
Maximum capacity 10 + 10 = 20 ISO drawers 100 mm height

Estructura monobloque de acero inoxidable AISI-304
Ensamblaje con remaches y soldadura TIG
Puertas con bloqueo de llave
Cajones ISO 400 x 600 mm
Capacidad máxima 10 + 10 = 20 cajones ISO altura 100 mm

DN Light grey doors Puertas gris claro
TT Transparent doors Puertas transparentes



720 DN.(3)62.(6)72.(2)73

UPPER SUPPLEMENT (Optional)
SUPLEMENTO SUPERIOR (Opcional)



68B

ADJUSTABLE SHELF (Optional)
BANDEJA REGULABLE (Opcional)



62 - 400 x 600 mm

RETENTION STOP (Optional)
TOPE DE RETENCIÓN (Opcional)
1 set per drawer 1 juego por cajón



TR

STORAGE TROLLEYS CARROS DE ALMACÉN
700 SERIES SERIE

ISO
640 x 480 mm

RETENTION STOP (Optional)
 TOPE DE RETENCIÓN (Opcional)
 1 set per drawer 1 juego por cajón



TR

DN Light grey doors Puertas gris claro
TT Transparent doors Puertas transparentes

UPPER SUPPLEMENT (Optional)
 SUPLEMENTO SUPERIOR (Opcional)



68



706 OP.(8)72.73



706 DN.(3)60.(2)72.73



706 DN.(2)60.(4)72.73



706 DN.(2)60.(2)72.(2)73



706 DN.(6)72.(2)73

EMERGENCY EMERGENCIA



EMERGENCY EMERGENCIA



EMERGENCY EMERGENCIA
SQM SERIES SERIE 

~~ISO~~
480 x 480 mm

 **EXTENSIVE MOBILITY TROLLEYS**
CARROS ALTA MOVILIDAD

SIMPLE WHEELS RUEDAS SIMPLES Ø 125 mm



DIVIDERS (Optional)
 SEPARADORES (Opcional)



Bexen cardio

DEFIBRILLATOR
 2 ROTATION AXLES

DESFIBRILADOR
 2 EJES DE GIRO

12 DMQ, 8 DSQ

SERUM
 SUEROS

CPR BOARD
 TABLA RCP

GAS BOTTLE
 Ø 110 / 140
 BOTELLA DE GAS
 Ø 110 / 140

- DISPOSABLE CONTAINER
 - GLOVE BOX
 - CONTENEDOR
 DESECHABLE
 - CAJA DE GUANTES

SEAL LOCKING
 BLOQUEO PARA
 PRECINTOS



Q260 R
 SQ161 R.12.14.28.32R.34.36.40

EMERGENCY EMERGENCIA
SQM SERIES SERIE CÉ

~~ISO~~

480 x 480 mm



EXTENSIVE MOBILITY TROLLEYS
CARROS ALTA MOVILIDAD

Security, manual locking
 Numbered disposable seals

Seguridad, bloqueo manual
 Precintos desechables numerados

SIMPLE WHEELS RUEDAS SIMPLES Ø 125 mm



SUCTION UNIT SUPPORT (Optional)
 SOPORTE ASPIRADOR (Opcional)



39



Q222 R
 SQ161 R.12.14.36.40
 Primary care Atención primaria



Q272 B
 SQ161 B.12.14.34.36.40



Q299 R
 SQ161 R.12.14.28.32R.34.36.39.40



Q224 R
 SQ161 R.12.14.26LW(R7Q).
 28EV.32R.34.36.40

**BROSELOW PAEDIATRIC EMERGENCY
EMERGENCIA PEDIÁTRICA BROSELOW
100 SERIES SERIE CE**

ISO

640 x 480 mm

BROSELOW PAEDIATRIC TAPE (Optional)
CINTA PEDIÁTRICA BROSELOW (Opcional)



TBR

SERUM
SUEROS



600 x 400 mm ISO drawers
HBR Broselow 9 colour card holder set
4 drawers divided into 2 equal parts
Cajones ISO 600 X 400 mm
HBR Conjunto portatarjetas 9 colores Broselow
4 cajones divididos en 2 partes iguales



GAS BOTTLE
Ø 110 / 140
BOTELLA DE GAS
Ø 110 / 140

DRAWER WITHOUT DIVIDER

CAJÓN SIN SEPARADOR

EACH DRAWER LOCKING
WITH SEAL

BLOQUEO DE CADA
CAJÓN CON PRECINTO

AUXILIARY DRAWER
WITHOUT DIVIDER

CAJÓN AUXILIAR
SIN SEPARADOR

1200 W
164M6 W.HBR.12B.14.36.40.(4)DS10

**EMERGENCY EMERGENCIA
100 SERIES SERIE CE**

**ISO
640 x 480 mm**

 **EXTENSIVE MOBILITY TROLLEYS
CARROS ALTA MOVILIDAD**

DOUBLE WHEELS RUEDAS DOBLES Ø 125 mm



DIVIDERS (Optional)
SEPARADORES (Opcional)



H5/16, (3)H10/4, H20/4

DEFIBRILLATOR
2 ROTATION AXLES

DESFIBRILADOR
2 EJES DE GIRO

SERUM
SUEROS

CPR BOARD
TABLA RCP

GAS BOTTLE
Ø 110 / 140
BOTELLA DE GAS
Ø 110 / 140

- DISPOSABLE CONTAINER
- GLOVE BOX

- CONTENEDOR
DESECHABLE
- CAJA DE GUANTES

SEAL LOCKING
BLOQUEO PARA
PRECINTOS



1296 R
165 R.12.14.28.32R.34.36.40

**EMERGENCY EMERGENCIA
100 SERIES SERIE CE**

**ISO
640 x 480 mm**

 **EXTENSIVE MOBILITY TROLLEYS
CARROS ALTA MOVILIDAD**

DIVIDERS (Optional)
SEPARADORES (Opcional)



(2)H5/16, (3)H10/4, H20/4

DEFIBRILLATOR
2 ROTATION AXLES

DESFIBRILADOR
2 EJES DE GIRO



SERUM

SUEROS

SYRINGES

JERINGUILLAS

GLOVE BOX

CAJA DE GUANTES

CPR BOARD

TABLA RCP

- DISPOSABLE CONTAINER
- GLOVE BOX

- CONTENEDOR
DESECHABLE
- CAJA DE GUANTES

SEAL LOCKING

BLOQUEO PARA
PRECINTOS

GAS BOTTLE

Ø 110 / 140

BOTELLA DE GAS

Ø 110 / 140



1210 R

162M6 R.12.14.26(RA5.A5.R1).28EV.32R.34.36.40

EMERGENCY EMERGENCIA
100 SERIES SERIE CE

ISO
640 x 480 mm



EXTENSIVE MOBILITY TROLLEYS
CARROS ALTA MOVILIDAD

Security, manual locking. Numbered disposable seals
 Seguridad, bloqueo manual. Precintos desechables numerados

SIMPLE WHEELS Ø 125 mm (Optional)
 RUEDAS SIMPLAS Ø 125 mm (Opcional)



WS12



1270 R.AXWD12.WS12
 165 R.AXWD12.WS12.12.14.28.36.40
 Primary care Atención primaria



1272 B.AXWD12.WS12
 165 B.AXWD12.WS12.12.14.34.36.40



1208 R
 162M6 R.12.14.28.32R.34.36.40



1254 R
 165 R.12.14.32R.34.36.40.46



1266 R
 165 R.12.14.28.34.36.40.44L



1299 R
 165 R.12.14.28.32R.34.36.39.40



1224 R
 165 R.12.14.26LW(R7).28EV.
 32R.34.36.40

TREATMENT CURAS



TREATMENT CURAS



**TREATMENT CURAS
SQM SERIES SERIE C€**

~~ISO~~
480 x 480 mm

HOSPITALIZATION UNITS

UNIDADES DE HOSPITALIZACIÓN



EXTENSIVE MOBILITY TROLLEYS
CARROS ALTA MOVILIDAD

TREATMENT TROLLEY PREPARED FOR DIGITALIZATION

CARRO DE CURAS PREPARADO PARA DIGITALIZACIÓN

COMPUTER

ORDENADOR

VESA SUPPORT
3 POSITIONS,
ADJUSTABLE

SOPORTE VESA
3 POSICIONES,
REGULABLE

- DISPOSABLE CONTAINER
- ALCOHOL,
CHLORHEXIDINE JARS

- CONTENEDOR
DESECHABLE
- BOTES ALCOHOL,
CLORHEXIDINA

3 GLOVE BOX

3 CAJAS DE
GUANTES

DIVIDERS (Optional)
SEPARADORES (Opcional)



4 DMQ, 8 DSQ

FOLD
DOWN TRAY

BANDEJA
ABATIBLE

WASTE BIN

CUBO DESECHOS



Q190 W

SQ161TXQ W.26M(R75QM).30.32L.46.50

**TREATMENT CURAS
SQM SERIES SERIE CÉ**

~~ISO~~
480 x 480 mm

HOSPITALIZATION UNITS

UNIDADES DE HOSPITALIZACIÓN

SIMPLE WHEELS RUEDAS SIMPLES Ø 125 mm



**EXTENSIVE MOBILITY TROLLEYS
CARROS ALTA MOVILIDAD**



Q102 W
SQ122 W.32R.50



Q105 B
SQ132 B.32R.50



Q126 W
SQ161 W.32L.33R.50
Phlebotomy Extracciones



Q106 W
SQ161 W.32R.46.50



Q108 W
SQ161 W.27.32R.46.50



Q112 W
SQ161 W.32R.46.48L.50



Q136 B
SQ161 B.26LW(R1Q).33R.46.50



Q142 B
SQ161 B.30.32L.46.50



Q158 W
SQ161 W.26(RA5Q.A5.R1Q).
30.33L.46.50

**TREATMENT CURAS
OPEN TROLLEY CARRO ABIERTO CE**

**ISO
640 x 480 mm**

HOSPITALIZATION UNITS

UNIDADES DE HOSPITALIZACIÓN



**EXTENSIVE MOBILITY TROLLEYS
CARROS ALTA MOVILIDAD**



Retention stop rails
Guías con tope de retención

CENTRAL SUPPORT (Optional)
SOPORTE CENTRAL (Opcional)



26LW(R1)

- DISPOSABLE CONTAINER
- GLOVE BOX

- CONTENEDOR
DESECHABLE
- CAJA DE GUANTES



WASTE BIN
CUBO DESECHOS

165AB.32R.50AB

**TREATMENT CURAS
100 SERIES SERIE CE**

**ISO
640 x 480 mm**

HOSPITALIZATION UNITS

UNIDADES DE HOSPITALIZACIÓN



**EXTENSIVE MOBILITY TROLLEYS
CARROS ALTA MOVILIDAD**

DOUBLE WHEELS RUEDAS DOBLES Ø 125 mm



DIVIDERS (Optional)
SEPARADORES (Opcional)



H5/8, (3)H10/4, H20/4

- DISPOSABLE CONTAINER
- ALCOHOL,
CHLORHEXIDINE JARS

- CONTENEDOR
DESECHABLE
- BOTES ALCOHOL,
CLORHEXIDINA

3 GLOVE BOX

3 CAJAS DE
GUANTES



WASTE BIN
CUBO DESECHOS

1606 B
165 B.32R.46.50

**TREATMENT CURAS
100 SERIES SERIE CE**

**ISO
640 x 480 mm**

HOSPITALIZATION UNITS

UNIDADES DE HOSPITALIZACIÓN



**EXTENSIVE MOBILITY TROLLEYS
CARROS ALTA MOVILIDAD**

DIVIDERS (Optional)
SEPARADORES (Opcional)



H5/8, (3)H10/4, H20/4

SYRINGES

JERINGUILLAS

ALCOHOL,
CHLORHEXIDINE JARS
BOTES ALCOHOL, CLORHEXIDINA

DISPOSABLE
CONTAINER

CONTENEDOR
DESECHABLE



Contaminated waste
on right side

Desechos contaminados
en lado derecho

3 GLOVE BOX

3 CAJAS DE
GUANTES

WASTE BIN
CUBO DESECHOS



1638 W

165 W.26(RA4.A5.R1).33R.46.50

**TREATMENT CURAS
100 SERIES SERIE CE**

**ISO
640 x 480 mm**

HOSPITALIZATION UNITS

UNIDADES DE HOSPITALIZACIÓN



EXTENSIVE MOBILITY TROLLEYS

CARROS ALTA MOVILIDAD

SIMPLE WHEELS Ø 125 mm (Optional)

RUEDAS SIMPLES Ø 125 mm (Opcional)



WS12



1601 W.AXWD12.WS12
122 W. AXWD12.WS12.32R.50



1602 G.AXWD12.WS12
133 G.AXWD12.WS12.32R.50



1607 W
165 W.32R.33L.46.50



1608 W
165 W.27.32R.46.50



1672 B
165 B.26(RA4.A5).32R.46.50



1625 B
165 B.32L.33R.46.50



1636 G
165 G.26LW(R1).33R.46.50



1642 B
165 B.30.32L.46.50

UNIT DOSE MEDICATION MEDICACIÓN UNIDOSIS



UNIT DOSE MEDICATION MEDICACIÓN UNIDOSIS



TRANSPORT TROLLEYS WITH CASSETTES CARROS DE TRANSPORTE CON CASETES

**ISO
640 x 480 mm**

600 SERIES SERIE

HOSPITAL PHARMACY

FARMACIA HOSPITALARIA

Handles, both sides

Key locking

C5, unit dose medication cassettes

600 x 400 mm ISO drawers

Ø 125 mm simple wheels

Asas, ambos lados

Bloqueo de llave

C5, casetes medicación unidosis

Cajones ISO 600 x 400 mm

Ruedas simples Ø 125 mm

Maximum 8 cassettes - 40 patients

Máximo 8 casetes - 40 pacientes

UPPER SUPPLEMENT (Optional)

SUPLEMENTO SUPERIOR (Opcional)



68

Maximum 10 cassettes - 50 patients

Máximo 10 casetes - 50 pacientes



608FAR.8MT.(6)C5.(2)72



610FAR.10MT.(10)C5

TRANSPORT TROLLEYS WITH CASSETTES
CARROS DE TRANSPORTE CON CASETES

ISO
850 x 640 mm

600 SERIES SERIE

HOSPITAL PHARMACY

FARMACIA HOSPITALARIA

Handles, both sides
 Key locking, both sides
 C5, unit dose medication cassettes
 600 x 400 mm ISO drawers
 Ø 150 mm double wheels
 Maximum 8 + 8 = 16 cassettes - 80 patients

Asas, ambos lados
 Bloqueo de llave, ambos lados
 C5, casetes medicación unidosis
 Cajones ISO 600 x 400 mm
 Ruedas dobles Ø 150 mm
 Máximo 8 + 8 = 16 casetes - 80 pacientes



UPPER SUPPLEMENT (Optional)
 SUPLEMENTO SUPERIOR (Opcional)



68B

2 DUAL LOCK WHEELS
 2 RUEDAS DOBLE BLOQUEO
 4 antistatic 4 antiestáticas



-  Fixed wheel
Rueda fija
-  Swivel wheel
Rueda giratoria
-  Locked wheel
Rueda bloqueada



616FAR.(2)8MT.(16)C5

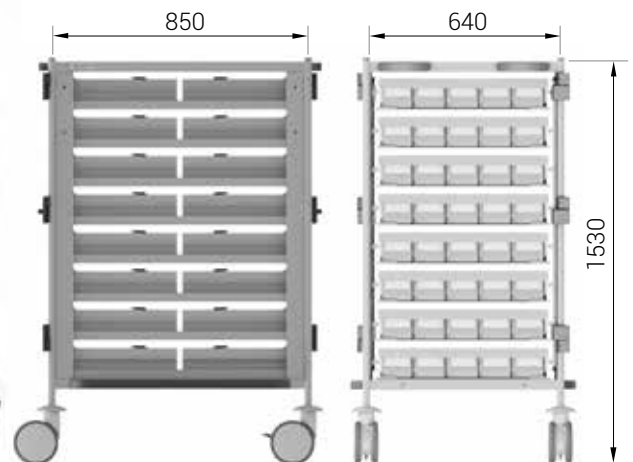

UNIT DOSE MEDICATION MEDICACIÓN UNIDOSIS
600 / 100 SERIES SERIE C€

ISO

INTERCHANGEABLE CASSETTE, 5 PATIENTS CASETE INTERCAMBIABLE, 5 PACIENTES

Compatible with pharmacy ISO furniture
 Polypropylene and aluminium, grey colour
 Cassette lock, epoxy painted steel
 Locked cassette, card upper part hidden, lower part visible
 Cassette total weight 4,6 kg.

Compatible con el mobiliario ISO de la farmacia
 Polipropileno y aluminio, color gris
 Bloqueo casete, acero pintado epoxi
 Casete bloqueado, parte superior de la tarjeta oculta, parte inferior visible
 Peso total del casete 4,6 kg.

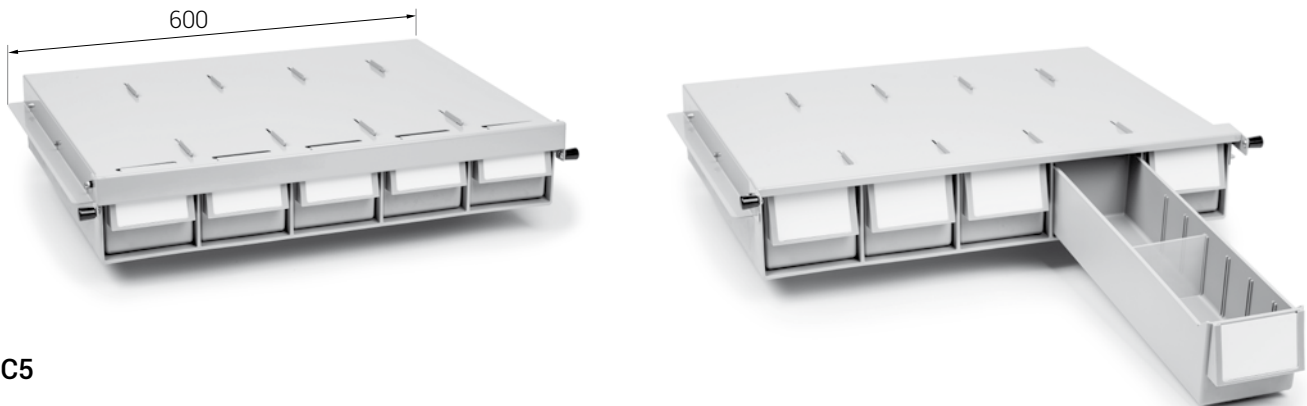

C5

MEDICATION CONTAINER CONTENEDOR DE MEDICACIÓN

Capacity: 3 litres
 ISO norm 7810 identification card, international standard
 Appropriate for intravenous therapy medication, re-packaged medication in unit doses, pills, prefilled syringes, syrups, etc

Capacidad: 3 litros
 Tarjeta de identificación norma ISO 7810, estándar internacional
 Adecuado para medicación de terapia intravenosa, medicación reenvasada en dosis unitarias, comprimidos, jeringas precargadas, jarabes, etc

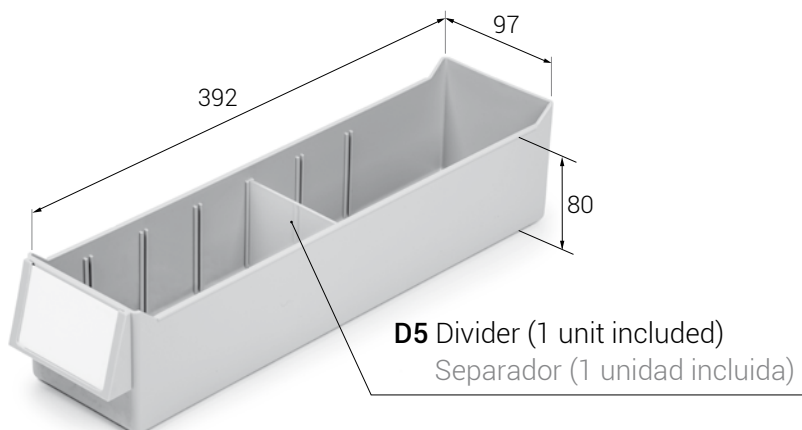

UNIT DOSE MEDICATION MEDICACIÓN UNIDOSIS
100 SERIES SERIE CÉ

ISO
640 x 480 mm

Key locking (included)

Bloqueo de llave (incluido)



106M6
106M6TX

Keyboard drawer, cable lead through
 Cajón para teclado, pasacables



108M6



110M6
110M6TX

Keyboard drawer, cable lead through
 Cajón para teclado, pasacables



112M6



113M6
113M6TX

Keyboard drawer, cable lead through
 Cajón para teclado, pasacables



114M6



117M6
117M6TX

Keyboard drawer, cable lead through
 Cajón para teclado, pasacables



118M6



120M6



TREATMENT - MEDICATION CURAS - MEDICACIÓN
100 SERIES SERIE C€

ISO
640 x 480 mm

HOSPITALIZATION UNITS

UNIDADES DE HOSPITALIZACIÓN



EXTENSIVE MOBILITY TROLLEYS
CARROS ALTA MOVILIDAD

A single health worker performs the treatment and administers the medication to the patient

Un único sanitario realiza las curas y administra la medicación al paciente

SYRINGES

JERINGUILLAS

**ALCOHOL,
 CHLORHEXIDINE
 JARS**

**BOTES ALCOHOL,
 CLORHEXIDINA**

**SERUM,
 PARACETAMOL DRAWER**

**CAJÓN SUEROS,
 PARACETAMOL**

DIVIDERS (Optional)
SEPARADORES (Opcional)



(2)H10/4, H20/4

**DISPOSABLE
 CONTAINER**

**CONTENEDOR
 DESECHABLE**

KEY LOCKING

BLOQUEO DE LLAVE

REMOVABLE CASSETTE

CASETE EXTRAÍBLE

WASTE BIN

CUBO DESECHOS



**Contaminated
 waste on right side**

**Desechos
 contaminados en
 lado derecho**



1807 B

108M6 B.26(RA4.A5).(2)32L.33R.50

UNIT DOSE MEDICATION MEDICACIÓN UNIDOSIS
100 SERIES SERIE CÉ

ISO
640 x 480 mm

HOSPITALIZATION UNITS

UNIDADES DE HOSPITALIZACIÓN



EXTENSIVE MOBILITY TROLLEYS
CARROS ALTA MOVILIDAD

DIVIDERS (Optional)
 SEPARADORES (Opcional)



H10/4, H20/4



COMMON MATERIAL
 PATIENTS DRAWER

CAJÓN MATERIAL
 COMÚN PACIENTES

3 GLOVE BOX

3 CAJAS DE
 GUANTES

SERUM,
 PARACETAMOL DRAWER

CAJÓN SUEROS,
 PARACETAMOL

DISPOSABLE
 CONTAINER

CONTENEDOR
 DESECHABLE

KEY LOCKING

BLOQUEO DE LLAVE

REMOVABLE CASSETTE

CASETE EXTRAÍBLE

WASTE BIN

CUBO DESECHOS

1809 W
 112M6 W.32R.46.50

UNIT DOSE MEDICATION MEDICACIÓN UNIDOSIS 100 SERIES SERIE CÉ

**ISO
640 x 480 mm**

HOSPITALIZATION UNITS

UNIDADES DE HOSPITALIZACIÓN

UNIT DOSE MEDICATION TROLLEY PREPARED FOR DIGITALIZATION

CARRO DE MÉDICACIÓN UNIDOSIS PREPARADO PARA DIGITALIZACIÓN



1891 B

110M6TX B.26M(R75M).(2)32L.32R.50.58

UNIT DOSE MEDICATION MEDICACIÓN UNIDOSIS
100 SERIES SERIE CÉ

ISO
640 x 480 mm



1808 W
 108M6 W.32R.46.50

Treatment - Medication
 Curas - Medicación



1817 W
 108M6 W.26(RA4.A5).27EV.
 (2)32L.33R.50

Treatment - Medication
 Curas - Medicación



1813 Y
 112M6 Y.27.32R.46.50



1818 Y
 112M6 Y.(2)32L.33R.50



1894 B
 114M6 B.32R.46.50



1890 W
 106M6TX W.26M(R75M).(2)32L.32R.50



1892 B
 113M6TX B.26M(R75M).(2)32L.32R.50



1893 B
 117M6TX B.26M(R75M).(2)32L.32R.50

TRANSPORT TROLLEYS CARROS DE TRANSPORTE
500 SERIES SERIE

480 x 480 mm

EXTENSIVE MOBILITY TROLLEYS
CARROS ALTA MOVILIDAD

Structure of AISI-304 stainless steel
 Assembly with TIG welding
 Load capacity 120 kg
 Ø 125 mm simple wheels
 2 antistatic, 2 with brake

Estructura de acero inoxidable AISI-304
 Ensamblaje con soldadura TIG
 Capacidad de carga 120 kg
 Ruedas simples Ø 125 mm
 2 antiestáticas, 2 con freno



SQ505



SQ510

640 x 480 mm



505



510

900 x 570 mm



520



530



540

INSTRUMENT TRANSPORT TROLLEYS

CARROS DE TRANSPORTE PARA INSTRUMENTAL

500 SERIES SERIE

900 x 630 mm

For 600 x 300 mm containers
 Monobloc structure of AISI-304 stainless steel
 Assembly with rivets and TIG welding
 Load capacity 150 kg
 Key locking
 Non-airtight phenolic doors

Para contenedores de 600 x 300 mm
 Estructura monobloque de acero inoxidable AISI-304
 Ensamblaje con remaches y soldadura TIG
 Capacidad de carga 150 kg
 Bloqueo de llave
 Puertas fenólico de cierre no hermético

UPPER SUPPLEMENT (Optional)
 SUPLEMENTO SUPERIOR (Opcional)





68B



567 DN

2 DUAL LOCK WHEELS
 Ø 125 mm
 2 RUEDAS DOBLE BLOQUEO
 Ø 125 mm

 Fixed wheel
 Rueda fija

 Swivel wheel
 Rueda giratoria

 Locked wheel
 Rueda bloqueada



566 DN Trolley with 2 smooth central shelves
 Carro con 2 estantes centrales lisos

567 DN Trolley with 2 perforated central shelves for ventilation
 Carro con 2 estantes centrales perforados para ventilación

TRANSPORT TROLLEYS CARROS DE TRANSPORTE
600 SERIES SERIE

ISO
640 x 480 mm

Monobloc structure of AISI-304 stainless steel
 Assembly with rivets and TIG welding
 Doors with key locking
 600 x 400 mm ISO drawers
 Maximum capacity 10 ISO drawers 100 mm height

Estructura monobloque de acero inoxidable AISI-304
 Ensamblaje con remaches y soldadura TIG
 Puertas con bloqueo de llave
 Cajones ISO 600 x 400 mm
 Capacidad máxima 10 cajones ISO altura 100 mm

DN Light grey doors Puertas gris claro
TT Transparent doors Puertas transparentes



606 DN.(6)72.(2)73

UPPER SUPPLEMENT (Optional)
 SUPLEMENTO SUPERIOR (Opcional)



68

ADJUSTABLE SHELF (Optional)
 BANDEJA REGULABLE (Opcional)



60 - 600 x 440 mm



RETENTION STOP (Optional)
 TOPE DE RETENCIÓN (Opcional)
 1 set per drawer 1 juego por cajón



TR

2 DUAL LOCK WHEELS Ø 125 mm
 2 RUEDAS DOBLE BLOQUEO Ø 125 mm



-  Fixed wheel
Rueda fija
-  Swivel wheel
Rueda giratoria
-  Locked wheel
Rueda bloqueada

**TRANSPORT TROLLEYS CARROS DE TRANSPORTE
600 SERIES SERIE**

**ISO
640 x 480 mm**



606 OP.(8)72.73



606 DN.(3)60



606 DN.(2)60.(4)72.73



606 DN.(8)72.73



631 DN.(2)60



632 DN.(2)60



651 DN



652 DN



657 DN

1655

TRANSPORT TROLLEYS CARROS DE TRANSPORTE
600 SERIES SERIE

ISO
900 x 630 mm

Monobloc structure of AISI-304 stainless steel
 Assembly with rivets and TIG welding
 Load capacity 160 kg
 Doors with key locking
 400 x 600 mm ISO drawers
 Maximum capacity 10 + 10 = 20 ISO drawers 100 mm height

Estructura monobloque de acero inoxidable AISI-304
 Ensamblaje con remaches y soldadura TIG
 Capacidad de carga 160 kg
 Puertas con bloqueo de llave
 Cajones ISO 400 x 600 mm
 Capacidad máxima 10 + 10 = 20 cajones ISO altura 100 mm

DN Light grey doors Puertas gris claro
TT Transparent doors Puertas transparentes

UPPER SUPPLEMENT (Optional)
 SUPLEMENTO SUPERIOR (Opcional)



68B

ADJUSTABLE SHELF (Optional)
 BANDEJA REGULABLE (Opcional)



62 - 400 x 600 mm



RETENTION STOP (Optional)
 TOPE DE RETENCIÓN (Opcional)
 1 set per drawer 1 juego por cajón



TR

2 DUAL LOCK WHEELS Ø 150 mm
 2 RUEDAS DOBLE BLOQUEO Ø 150 mm
 4 antistatic 4 antiestáticas



-  Fixed wheel
Rueda fija
-  Swivel wheel
Rueda giratoria
-  Locked wheel
Rueda bloqueada



620 DN.(12)72.(4)73

TRANSPORT TROLLEYS CARROS DE TRANSPORTE 600 SERIES SERIE

Monobloc structure of AISI-304 stainless steel
 Assembly with rivets and TIG welding
 Handles, both sides
 600 x 400 mm ISO drawers
 Ø 125 mm simple wheels

Estructura monobloque de acero inoxidable AISI-304
 Ensamblaje con remaches y soldadura TIG
 Asas, ambos lados
 Cajones ISO 600 x 400 mm
 Ruedas simples Ø 125 mm

ISO 640 x 480 mm

Load capacity 100 kg
 Maximum 10 ISO drawers 100 mm height



Capacidad de carga 100 kg
 Máximo 10 cajones ISO altura 100 mm



610TRT.(8)72.73

2 DUAL LOCK WHEELS (Optional)
 2 RUEDAS DOBLE BLOQUEO (Opcional)



-  Fixed wheel
Rueda fija
-  Swivel wheel
Rueda giratoria
-  Locked wheel
Rueda bloqueada

WDD12 - Ø 125 mm - Mod. 610TRT

WDD15 - Ø 150 mm - Mod. 620TRT

ISO 880 x 680 mm

Load capacity 160 kg
 Maximum 20 ISO drawers 100 mm height

Capacidad de carga 160 kg
 Máximo 20 cajones ISO altura 100 mm



620TRT.(16)72.(2)73

SQUARE TROLLEYS CARROS CUADRADOS
SQS SERIES SERIE C E

~~ISO~~
480 x 480 mm



STATIC TROLLEYS
CARROS ESTÁTICOS



SQ010



SQ005



SQ040



SQ021

SQ021TXQ

Keyboard drawer, cable
lead through

Cajón para teclado, pasacables



SQ022



SQ032



SQ033



SQ061

SQ061TXQ

Keyboard drawer, cable
lead through

Cajón para teclado, pasacables



SQ065

OPEN TROLLEYS CARROS ABIERTOS CE

**ISO
640 x 480 mm**



**STATIC TROLLEYS
CARROS ESTÁTICOS**

- The work surface design allows you to move the trolley without needing the push handle
- Ø 100 mm wheels, 2 antistatic, 2 with brake
- El diseño de la superficie de trabajo permite manejar el carro sin necesidad de tirador
- Ruedas Ø 100 mm, 2 antiestáticas, 2 con freno



322AB



364AB



365AB



**EXTENSIVE MOBILITY TROLLEYS
CARROS ALTA MOVILIDAD**

- Elevated push handle left side
- Bumpers for hits
- Ø 125 mm simple wheels, 2 antistatic, 2 with brake
- Tirador elevado lado izquierdo
- Protectores paragolpes
- Ruedas simples Ø 125 mm, 2 antiestáticas, 2 con freno



164AB



165AB



166AB

SIMPLE TROLLEYS CARROS SIMPLES
300 SERIES SERIE **CE**

ISO
640 x 480 mm

 **STATIC TROLLEYS**
CARROS ESTÁTICOS



310



305
305MRI



321
321MRI
321TX
 Keyboard drawer, cable
 lead through
 Cajón para teclado, pasacables



322
322MRI



332
332TX
 Keyboard drawer, cable
 lead through
 Cajón para teclado, pasacables



333



334



341



346

SIMPLE TROLLEYS CARROS SIMPLES
300 SERIES SERIE **CE**

ISO
640 x 480 mm



STATIC TROLLEYS
CARROS ESTÁTICOS

M6 Structure for 6 100 mm ISO drawers

M6 Estructura para 6 cajones ISO 100 mm



364
364MRI



365
365MRI



366
366MRI



361M6



362M6
362M6TX
 Keyboard drawer, cable
 lead through
 Cajón para teclado, pasacables



364M6



365M6



366M6



367M6

DOUBLE TROLLEYS CARROS DOBLES
300 SERIES SERIE **CE**

ISO
900 x 630 mm

 **STATIC TROLLEYS**
CARROS ESTÁTICOS



396LW
900 x 570 mm
 Instrument table
 Mesa de instrumental



398LW
1130 x 570 mm
 Instrument table
 Mesa de instrumental



N310



N305



N321



N322



N364



N365



N366

DOUBLE TROLLEYS CARROS DOBLES
300 SERIES SERIE CÉ

ISO
900 x 630 mm



STATIC TROLLEYS
CARROS ESTÁTICOS

M12 Structure for 12 100 mm ISO drawers

M12 Estructura para 12 cajones ISO 100 mm



N361M12



N362M12



N364M12



N365M12



N366M12



N367M12

LOW TROLLEYS, REDUCED HEIGHT
CARROS BAJOS, ALTURA REDUCIDA 

LOW SQUARE TROLLEYS **CARROS CUADRADOS BAJOS**

~~ISO~~

480 x 480 mm



STATIC TROLLEYS
CARROS ESTÁTICOS



SQ022LW



SQ061M4LW



SQ064M4LW

LOW SIMPLE TROLLEYS **CARROS SIMPLES BAJOS**

ISO

640 x 480 mm



STATIC TROLLEYS
CARROS ESTÁTICOS

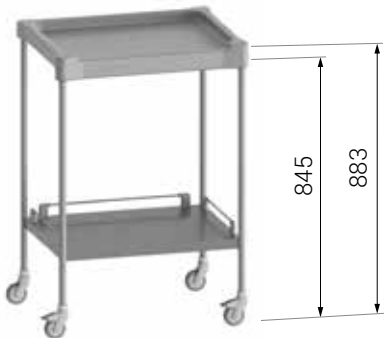

310LW

Ø 75 mm simple wheels
 Ruedas simples Ø 75 mm



361M5LW



362M5LW



364M5LW



365M5LW



366M5LW

To store it under 900 mm work tables
 For users working in sitting position

Para guardarlos debajo de mesas de trabajo de 900 mm
 Para el usuario que trabaja en posición sentada

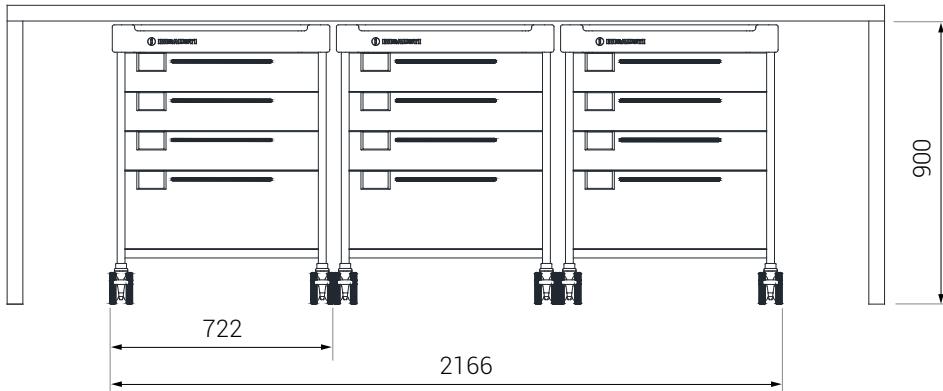

LOW DOUBLE TROLLEYS CARROS DOBLES BAJOS

**ISO
 900 x 630 mm**

 **STATIC TROLLEYS**
CARROS ESTÁTICOS



N361M10LW



N362M10LW



N364M10LW



N365M10LW



N366M10LW

SQUARE TROLLEYS CARROS CUADRADOS
SQM SERIES SERIE C€

~~ISO~~
480 x 480 mm

 **EXTENSIVE MOBILITY TROLLEYS**
CARROS ALTA MOVILIDAD

SIMPLE WHEELS RUEDAS SIMPLAS Ø 125 mm



SQ121
SQ121TXQ

Keyboard drawer, cable
lead through
Cajón para teclado, pasacables



SQ122



SQ132



SQ133



SQ161
SQ161TXQ

Keyboard drawer, cable
lead through
Cajón para teclado, pasacables



SQ165

SIMPLE TROLLEYS CARROS SIMPLES
100 SERIES SERIE CÉ

ISO
640 x 480 mm



EXTENSIVE MOBILITY TROLLEYS
CARROS ALTA MOVILIDAD

M6 Structure for 6 100 mm ISO drawers

M6 Estructura para 6 cajones ISO 100 mm



122 W.AXWD12.WS12
 Ø 125 mm simple wheels
 Ruedas simples Ø 125 mm



133 W.AXWD12.WS12
 Ø 125 mm simple wheels
 Ruedas simples Ø 125 mm



164



165



166



162M6
162M6TX
 Keyboard drawer, cable lead through
 Cajón para teclado, pasacables



164M6



165M6



166M6

ACCESSORIES ACCESORIOS

SQUARE TROLLEY DIVIDERS SEPARADORES CARRO CUADRADO

PC, polycarbonate PC, policarbonato

DMQ - Height Altura 57 mm



DSQ - Height Altura 130 mm

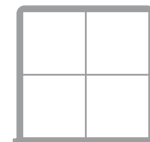
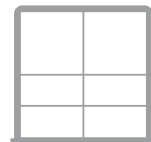
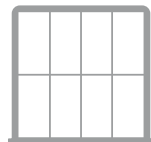
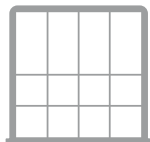
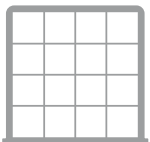

ACCESSORIES ACCESORIOS

ISO DRAWER DIVIDER SET CONJUNTO SEPARADORES CAJONES ISO

Dividers for 600 x 400 mm ISO drawers
PC, polycarbonate

Separadores para cajones ISO 600 x 400 mm
PC, policarbonato

Drawer Cajón 50 mm
DL5, DS5

Drawer Cajón 100 mm
DL10, DS10

Drawer Cajón 200 mm
DL20, DS20

DS5 400 mm
DL5 600 mm



CLIP FOR DIVIDERS
CLIP PARA SEPARADORES



DT



H5/16

ISO drawer Cajón ISO 50 mm

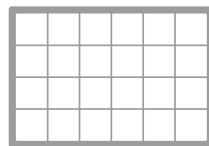

H5/24

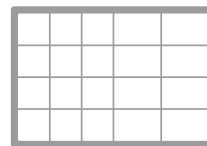

H5/20

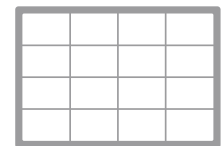

H5/16

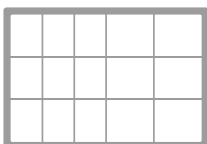

H5/15

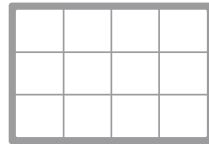

H5/12, H10/12

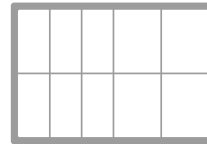

H5/10, H10/10

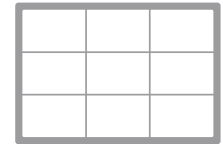

H5/9, H10/9, H20/9

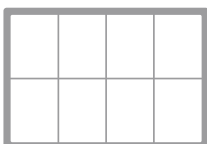

H5/8, H10/8, H20/8

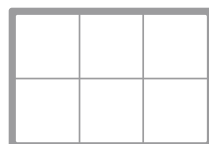

H5/6, H10/6, H20/6

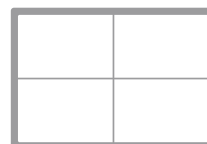

H10/4, H20/4

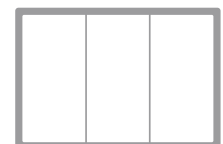

H10/3, H20/3

ACCESSORIES ACCESORIOS

KEY LOCKING BLOQUEO DE LLAVE



10 Square, simple trolley, total locking
Carro cuadrado, simple, bloqueo total

10N2 Double trolley, total locking
Left side, right side
Carro doble, bloqueo total
Lado izquierdo, lado derecho



10D Square trolley, 2 57 mm drawers locking
Simple trolley, 2 50/100 mm ISO drawers locking
Carro cuadrado, bloqueo 2 cajones 57 mm
Carro simple, bloqueo 2 cajones ISO 50/100 mm

10DN2 Double trolley, 4 ISO drawers locking
50/100 mm left side, 50/100 mm right side
Carro doble, bloqueo 4 cajones ISO
2 lado izquierdo 50/100 mm, 2 lado derecho 50/100 mm



10M2 Square trolley, 2 130 mm drawers locking
Simple trolley, 2 100 mm ISO drawers locking
Carro cuadrado, bloqueo 2 cajones 130 mm
Carro simple, bloqueo 2 cajones ISO 100 mm

10JK Set of 4 keys
Juego de 4 llaves

All the locks include 4 keys Todos los bloqueos incluyen 4 llaves

CODE LOCKING BLOQUEO DE CÓDIGO



10COD
Square, simple trolley, total locking
Carro cuadrado, simple, bloqueo total

10CODN2
Double trolley, total locking
Left side, right side
Carro doble, bloqueo total
Lado izquierdo, lado derecho

10CK
Security key for code locking
Llave de seguridad para bloqueo de código

The lock includes 1 key El bloqueo incluye 1 llave

ACCESSORIES ACCESORIOS

SEAL LOCKING BLOQUEO PARA PRECINTOS



12 Square, simple trolley, total locking
Carro cuadrado, simple, bloqueo total

12N2 Double trolley, total locking
Left side, right side
Carro doble, bloqueo total
Lado izquierdo, lado derecho



12D Square trolley, 2 57 mm drawers locking
Simple trolley, 2 50/100 mm ISO drawers locking
Carro cuadrado, bloqueo 2 cajones 57 mm
Carro simple, bloqueo 2 cajones ISO 50/100 mm

12DN2 Double trolley, 4 ISO drawers locking
50/100 mm left side, 50/100 mm right side
Carro doble, bloqueo 4 cajones ISO
2 lado izquierdo 50/100 mm, 2 lado derecho 50/100 mm

INDIVIDUAL SEAL LOCKING BLOQUEO INDIVIDUAL PARA PRECINTOS

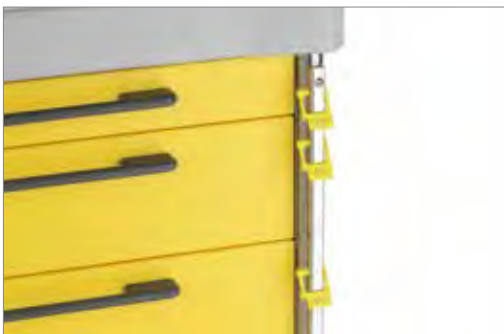

12B Square, simple trolley, maximum 11 seals
Carro cuadrado, simple, máximo 11 precintos

12BN2 Double trolley, maximum 22 seals
11 left side, 11 right side
Carro doble, máximo 22 precintos
11 lado izquierdo, 11 lado derecho

NUMBERED DISPOSABLE SEALS PRECINTOS DESECHABLES NUMERADOS



14 Number for the control of hospital emergencies
100 units

Numeración para el control de emergencias
hospitalarias
100 unidades

RIGHT SIDE ACCESSORIES ACCESORIOS LADO DERECHO

FOLD DOWN TRAY BANDEJA ABATIBLE

Polyethylene Polietileno
Protection on all 4 sides Protección 4 lados
Trolley Carro 480 x 480 mm
640 x 480 mm



30

SUCTION UNIT SUPPORT SOPORTE ASPIRADOR

Useful dimensions Dimensiones útiles 250 x 420 mm
Max. 12 kg
Epoxy painted steel Acero pintado epoxi



39

13 LITRES BIN CUBO 13 LITROS



50

TWO 13 LITRES BINS DOS CUBOS 13 LITROS



50B

26 LITRES BIN CUBO 26 LITROS



51

25 LITRES PEDAL BIN CUBO DE PEDAL 25 LITROS



57

LEFT SIDE ACCESSORIES ACCESORIOS LADO IZQUIERDO

3 GLOVE BOX HOLDER SOPORTE 3 CAJAS DE GUANTES

Depth Profundidad 87 mm
Adjustable width Anchura regulable 200 - 260 mm



46
460P Open trolley Carro abierto

GAS BOTTLE STAND SOPORTE PARA BOTELLAS DE GAS

Ø 110 mm / Ø 140 mm. Max. 18 kg
Supported with ref. 44L, 46, 59L
Compatible con ref. 44L, 46, 59L



36

LEFT - RIGHT SIDE ACCESSORIES ACCESORIOS LADO IZQUIERDO - DERECHO

CATHETER CONTAINER CONTENEDOR DE CATÉTERES

Height Altura 420 mm
Not supported with No compatible con ref. 30, 46



44L Left Izquierdo
44R Right Derecho
D44 Divider Separador

A4 DOCUMENT HOLDER PORTADOCUMENTOS A4

Height Altura 240 mm
Dimensions Dimensiones 235 x 55 mm



59L Left Izquierdo
59R Right Derecho

LEFT - RIGHT SIDE ACCESSORIES

ACCESORIOS LADO IZQUIERDO - DERECHO

DISPOSABLE CONTAINER SUPPORT APOYO CONTENEDOR DESECHABLE

Max. 10 litres 10 litros

Epoxy painted steel Acero pintado epoxi

↑ Variable height, bridle attachment
↓ Altura variable, fijación con brida



33L Left Izquierdo

33R Right Derecho

SIDE SUPPORT SOPORTE LATERAL

Width Anchura 155 mm



Square, simple trolley Carro cuadrado, simple

32L Left Izquierdo

32R Right Derecho

Double trolley Carro doble

32NL Left Izquierdo

32NR Right Derecho

FIXING RAIL RIEL DE FIJACIÓN

25 x 10 mm Max. 20 kg

Stainless steel Acero inoxidable



Square, simple trolley Carro cuadrado, simple

37L Left Izquierdo

37R Right Derecho

Double trolley Carro doble

37NL Left Izquierdo

37NR Right Derecho

BACK SIDE ACCESSORIES ACCESORIOS PARTE POSTERIOR

**BACK FIXING RAIL
RIEL DE FIJACIÓN POSTERIOR**

☒ 25 x 10 mm Max. 20 kg
Stainless steel Acero inoxidable



37QT Square Cuadrado
37T Simple

**CPR BOARD
TABLA RCP
(REANIMACIÓN CARDIOPULMONAR)**



Dimensions Dimensiones 660 x 440 mm



34

**ELECTRICAL CONNECTION BASE
BASE DE CONEXIÓN ELÉCTRICA**



3 metres cable Cable 3 metros
Integrated cable support Recogecables integrado



38EU SCHUKO, type F Tipo F
38US USA, type B Tipo B
38UK UK, type G Tipo G
38CH Switzerland, type J Suiza, tipo J

ACCESSORIES ACCESORIOS

GLASS DISPENSER DISPENSADOR DE VASOS

For glasses of Para vasos de 150, 200, 220 ml
Max. 70 glasses 70 vasos



- 47L Left Izquierdo
- 47R Right Derecho
- 47 Left side assembly in elevated accesory
Montaje lado izquierdo en accesorio elevado

HANGER SUPPORT SOPORTE COLGADOR

Max. 6 kg



58

SERUM HOLDER PORTASUEROS



Stainless steel Acero inoxidable
Max. 4 kg
Adjustable height Altura regulable



40

ELEVATED HANGER SUPPORT SOPORTE COLGADOR ELEVADO



Stainless steel Acero inoxidable
Max. 4 kg
For serum preparation Para preparación de sueros



41

ACCESSORIES ACCESORIOS

**GEL DISPENSER
DISPENSADOR DE GEL**

500 ml rechargeable jar
Bote recargable 500 ml



48L Left Izquierdo
48R Right Derecho

**DRIP TRAY
BANDEJA DE GOTEO**

Manually removable
Desmontable manualmente



GT



48Q Square trolley Carro cuadrado
Assembly Montaje en RA5Q, RA4Q



48 Right side assembly in elevated accessory
Montaje lado derecho en accesorio elevado

ACCESSORIES ACCESORIOS

ROTATING ARM FOR DEFIBRILLATOR BRAZO GIRATORIO PARA DESFIBRILADOR

Right side assembly
Two rotation axles
Fixing strap

Montaje lado derecho
Dos ejes de giro
Correa de fijación

Useful dimensions Dimensiones útiles 350 x 350 mm
Max. 10 kg



28



28EV Assembly in elevated accessory
Montaje en accesorio elevado

LAPTOP BASE BASE PARA ORDENADOR PORTÁTIL

Left side assembly
Rotating and tilting base
Padlock with security cable

Montaje lado izquierdo
Base giratoria y basculante
Candado con cable de fijación

Width Anchura 398 - 308 mm Depth Profundidad 270 mm



27



27EV Assembly in elevated accessory
Montaje en accesorio elevado

ACCESSORIES ACCESORIOS

TABLET SUPPORT SOPORTE PARA TABLETA

Variable height Altura variable

Width Anchura 195 - 300 mm

Tablets from 7" to 11" Tabletillas desde 7" a 11"

Anti-theft system with key

Sistema antirrobo con llave



63L Left Izquierdo

63R Right Derecho

63 Assembly in elevated accessory Montaje en accesorio elevado

MONITOR SUPPORT SOPORTE PARA MONITOR

3 Positions, height adjustable

Tilt and rotation adjustable

Epoxy painted steel

3 Posiciones, regulable en altura

Regulable en inclinación y giro

Acero pintado epoxi

VESA 75 / 100 mm



26M(R75QM) Square Cuadrado

26M(R75M) Simple

ELEVATED ACCESSORIES ACCESORIOS ELEVADOS

**ELEVATED TUBE SET
JUEGO TUBOS ELEVADOS**

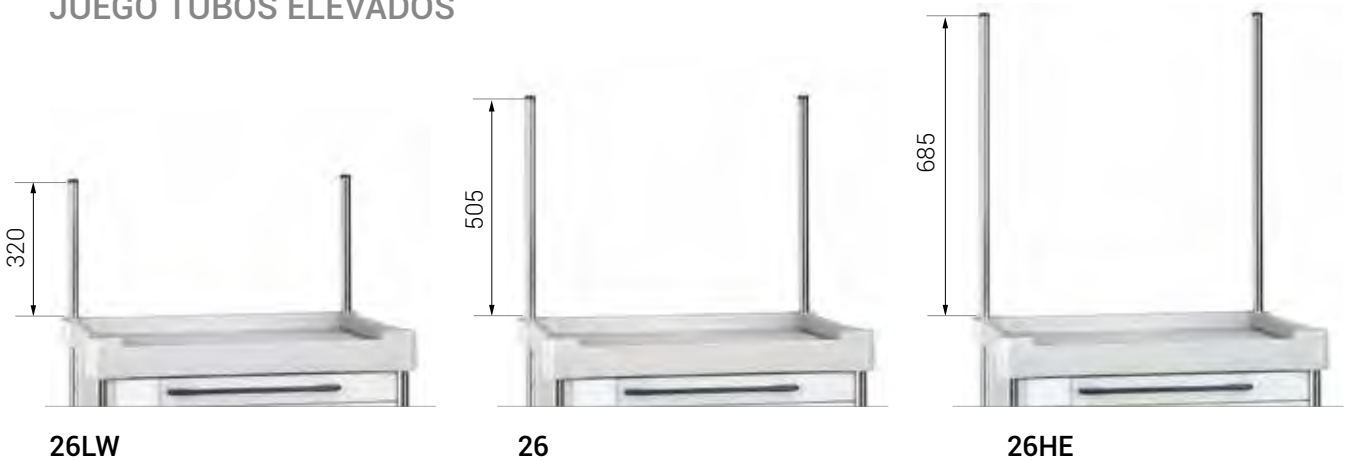

26LW

26

26HE



RA3FQ.A5F Square Cuadrado
RA3F.A5F Simple

FIFO

**BINS DISPENSER
DISPENSADOR DE CAJITAS**



RA5Q Square Cuadrado
RA5 Simple
RA5N Double Doble



RA4Q Square Cuadrado
RA4 Simple
RA4N Double Doble

**CENTRAL SUPPORT
SOPORTE CENTRAL**

Epoxy painted steel
Acero pintado epoxi
Depth Profundidad 150 mm
Max. 22 kg



R1Q Square Cuadrado
R1 Simple
R1N Double Doble

**CENTRAL SHELF
ESTANTE CENTRAL**

Epoxy painted steel
Acero pintado epoxi
Depth Profundidad 230 mm
Max. 22 kg



R2Q Square Cuadrado
R2 Simple
R2N Double Doble

**CENTRAL RAIL
RIEL CENTRAL**

Stainless steel Acero inoxidable
25 x 10 mm
Max. 15 kg



R7Q Square Cuadrado
R7 Simple
R7N Double Doble

ELEVATED ACCESSORIES ACCESORIOS ELEVADOS

480 x 480 mm
640 x 480 mm
900 x 630 mm

↑ Variable height, bridles attachment
 ↓ Altura variable, fijación con bridas



26LW(R1Q) Square Cuadrado
26LW(R1) Simple
26LW(R1N) Double Doble



26LW(R2Q) Square Cuadrado
26LW(R2) Simple
26LW(R2N) Double Doble



26LW(R7Q) Square Cuadrado
26LW(R7) Simple
26LW(R7N) Double Doble



26(R7Q) Square Cuadrado
26(R7) Simple
26(R7N) Double Doble



26(R1Q.R1Q) Square Cuadrado
26(R1.R1) Simple
26(R1N.R1N) Double Doble



26(R2Q.R2Q) Square Cuadrado
26(R2.R2) Simple
26(R2N.R2N) Double Doble



26(R7Q.R7Q) Square Cuadrado
26(R7.R7) Simple
26(R7N.R7N) Double Doble



26(R2Q.R1Q) Square Cuadrado
26(R2.R1) Simple
26(R2N.R1N) Double Doble



26(R2Q.R7Q) Square Cuadrado
26(R2.R7) Simple
26(R2N.R7N) Double Doble

ELEVATED ACCESSORIES ACCESORIOS ELEVADOS

**480 x 480 mm
640 x 480 mm**

↑ Variable height, bridles attachment
↓ Altura variable, fijación con bridas



26(RA5Q.A5) Square Cuadrado
26(RA4Q.A5) Square Cuadrado

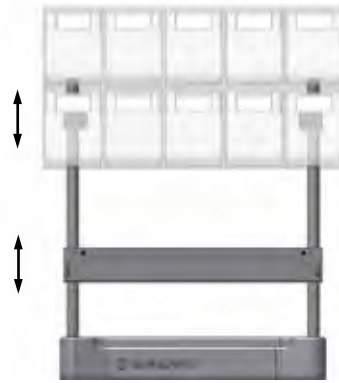

26(RA5Q.A5.R1Q) Square Cuadrado
26(RA4Q.A5.R1Q) Square Cuadrado



26(RA5Q.A5.R2Q) Square Cuadrado
26(RA4Q.A5.R2Q) Square Cuadrado



26(RA5.A5) Simple



26(RA4.A5) Simple

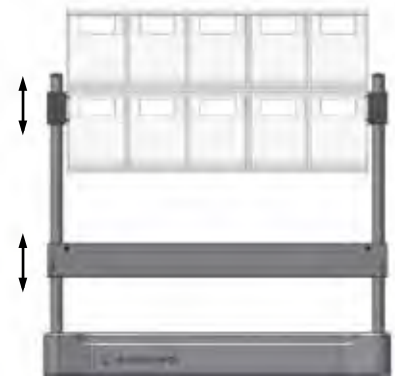

26(RA5.A5.R1) Simple



26(RA4.A5.R1) Simple



26(RA5.A5.R2) Simple



26(RA4.A5.R2) Simple

ELEVATED ACCESSORIES ACCESORIOS ELEVADOS

900 x 630 mm

↑ Variable height, bridles attachment
 ↓ Altura variable, fijación con bridas

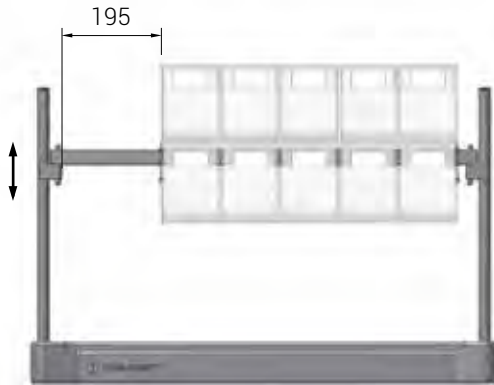

26(RA5N.A5) Double Doble

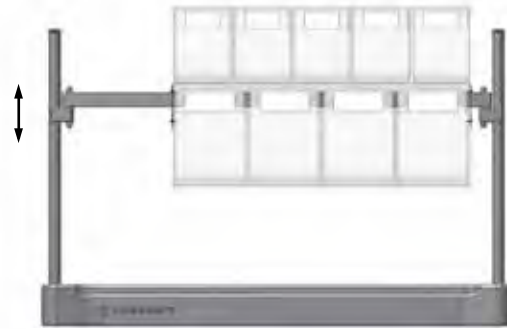

26(RA4N.A5) Double Doble



26(RA5N.A5.R1N) Double Doble



26(RA4N.A5.R1N) Double Doble

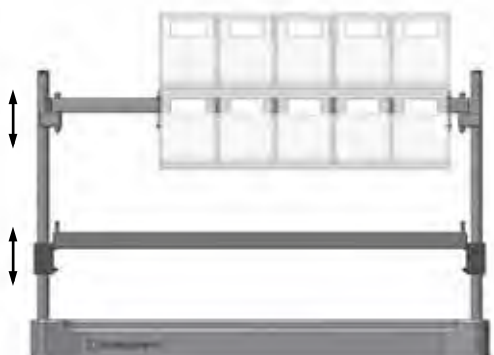

26(RA5N.A5.R2N) Double Doble

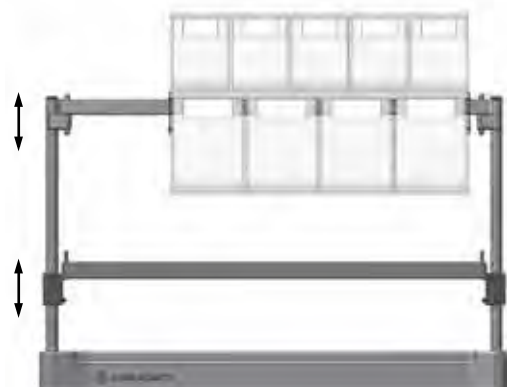

26(RA4N.A5.R2N) Double Doble

ISO FURNITURE ACCESSORIES ACCESORIOS PARA MOBILIARIO ISO
600 x 400 mm ISO DRAWERS CAJONES ISO 600 x 400 mm

ISO DRAWER LID TAPA CAJÓN ISO



LD 2 holes for seals
2 agujeros para precintos

50 mm ABS ISO DRAWER
CAJÓN ISO 50 mm ABS

8 Litres Litros



71
71LD 2 holes for seals
2 agujeros para precintos

100 mm ABS ISO DRAWER
CAJÓN ISO 100 mm ABS

19 Litres Litros



72

100 mm ABS ISO CLOSED DRAWER
CAJÓN ISO CERRADO 100 mm ABS

19 Litres Litros



72C

200 mm ABS ISO DRAWER
CAJÓN ISO 200 mm ABS

33 Litres Litros



73

200 mm ABS ISO CLOSED DRAWER
CAJÓN ISO CERRADO 200 mm ABS

33 Litres Litros



73C

ISO FURNITURE ACCESSORIES ACCESORIOS PARA MOBILIARIO ISO
600 x 400 mm ISO DRAWERS CAJONES ISO 600 x 400 mm

CARD HOLDER FOR OPEN DRAWER
PORTATARJETAS PARA CAJÓN
ABIERTO



HCOP

NARCOTICS SECURITY BOX
CAJA SEGURIDAD NARCÓTICOS

Height Altura 80 mm
 Dimensions Dimensiones 150 x 120 mm
 Key locking Bloqueo de llave



CSM Separated Suelta
CSM1 Drawer fixed Fijación cajón

50 mm POLYCARBONATE ISO DRAWER
CAJÓN ISO 50 mm POLICARBONATO
 8 Litres Litros



71PC

100 mm POLYCARBONATE ISO DRAWER
CAJÓN ISO 100 mm POLICARBONATO
 19 Litres Litros



72PC

200 mm POLYCARBONATE ISO DRAWER
CAJÓN ISO 200 mm POLICARBONATO
 33 Litres Litros



73PC

240 mm HIGH ABS ISO DRAWER
CAJÓN ABS ISO ALTURA 240 mm



73BT Loose drawer unit Cajón suelto
AX73.73BT Mounted on trolley
 Montado en carro

ISO FURNITURE ACCESSORIES ACCESORIOS PARA MOBILIARIO ISO

**RAIL FOR CATHETERS
RIEL PARA CATÉTERES**

Stainless steel Acero inoxidable
Adjustable height Altura regulable



R7CAT3 3 hooks 3 ganchos Mod. 706
R7CAT4 4 hooks 4 ganchos Mod. 720

**ADJUSTABLE SHELF FOR CATHETERS
BANDEJA REGULABLE PARA CATÉTERES**



60CAT 25 hooks 25 colgadores Mod. 706
62CAT 15 hooks 15 colgadores Mod. 720

**ADJUSTABLE SHELF
BANDEJA REGULABLE**

Phenolic Fenólico Max. 22 kg



60 600 x 440 mm - Mod. 706 / 606
62 400 x 600 mm - Mod. 720 / 620

**ADJUSTABLE SHELF DIVIDER
SEPARADOR BANDEJA REGULABLE**

Epoxi painted steel Acero pintado epoxi



DV

**ENDOSCOPES ADJUSTABLE SHELF
BANDEJA REGULABLE ENDOSCOPIOS**

Phenolic Fenólico
10 endoscopes 10 endoscopios



60ED

**RETENTION STOP
TOPE DE RETENCIÓN**

1 set per drawer 1 juego por cajón



TR

Faithful to our slogan "Design, Build, Innovate" Insausti has constructed a new forefront factory with the latest technology.

Inaugurated in October 2023 over a land plot of 7.700 m², the building with 4.600 m² houses a logistic plant, components assembly area and several production lines.

Fieles a nuestro eslogan "Diseñar, Construir, Innovar" Insausti ha construido una nueva fábrica de vanguardia, con la última tecnología.

Inaugurada en octubre de 2023 sobre unas instalaciones de 7.700 m² el edificio de 4.600 m² cuenta con planta de logística, área de montaje de componentes y varias líneas de producción.





All articles with EC mark are considered as medical device class I and follow regulation (EU) 2017/745 Sanitary licence 7439-PS. SRN: ES-MF-000003261.

Todos los artículos con la marca CE se consideran producto sanitario de clase I y siguen el reglamento (UE) 2017/745 Licencia Sanitaria 7439-PS. SRN: ES-MF-000003261.

Guarantee period: 5 years

Periodo de garantía: 5 años

INSAUSTI reserves the right to make modifications

INSAUSTI se reserva el derecho a modificaciones



User manual Manual de usuario



Sustainability is a key part of our business.

The new photovoltaic installation generates the clean green energy needed to manufacture Insausti branded medical trolleys, a milestone in our commitment to sustainable activity.

La sostenibilidad es una parte fundamental en nuestra empresa.

La nueva instalación fotovoltaica produce la energía limpia necesaria para la fabricación de los carros médicos marca Insausti, un hito en nuestro compromiso con una actividad sostenible.



30 YEAR SERVICE LIFE
AÑOS DE VIDA ÚTIL



Since Desde
1991



Designed and manufactured in Spain

Diseñado y fabricado en España



INSAUSTI MATERIAL CLÍNICO S.L.U.

Pol. Ind. Comarca 2 C/A nave 3
31191 Barbatáin (España - Spain)

Tel.: (+34) 948 149 588

e-mail: insausti@insausti.eu

www.insausti.eu



2025